



A I R S O U R C E H E A T P U M P S



R E N E W A B L E E N E R G Y M A D E S I M P L E

For heating technology **Trianco lead the way**

An engineering pedigree

For many years Trianco have pioneered the manufacture of sophisticated domestic heating boilers fired by oil, solid fuel or electricity according to the varied needs of individual consumer demand. In fact Trianco are currently the market leaders in the production of electric wet-system boilers.

More recently the company has developed a versatile range of condensing oil boilers in line with Government stipulation to improve domestic energy consumption. At Trianco we have ensured that as much of our manufacturing output as possible achieves band A and B in the SEDBUK ratings.

The next phase

But with limited natural resources at our disposal, we all have to be even more conscientious. The world is constantly looking for effective ways of reducing waste and improving the efficiency of household appliances. So in true pioneering spirit, we have tasked our engineers to meet the latest challenges posed by the delicate balance of world ecology. Trianco are entering a new era of domestic heating, confidently rising to the challenge of renewable energy.

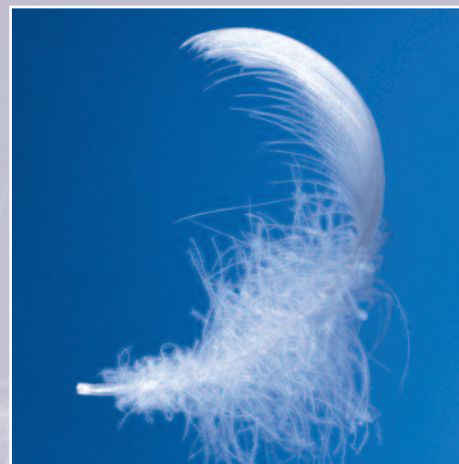

The way ahead with **Renewable Energy**

Conserving our resources

It's a well known fact that our concerns about harmful carbon emissions caused by burning of fossil fuels have only been matched by the worry that this is a finite resource which will one day be depleted. This is already being evidenced by the fact that North Sea gas is running out, potentially becoming completely exhausted in as little as ten years time. These fears have led to various ways of preventing climate change due to the pollution caused by our use of fossil fuels in our normal daily life. The solution to carbon off-setting is to do with more than just planting a few extra trees.

Harnessing solar energy

The ever increasing use of wind, water and solar power, not only in developed but also in developing countries, has been much publicised over the years. The mass production of electricity using renewable energy sources has become commonplace only more recently, and it's accepted that we must all adapt quickly to these very necessary changes in our lifestyles.

But exactly what is renewable energy? It's defined as 'energy that is derived from resources that are regenerative or cannot be depleted'. Trianco have now developed the most practical application of this new technology and adapted it for use in domestic heating situations.

A viable alternative

This lesser known source of heating is obtained by tapping into the heat generated by the earth itself. It can be done in various ways - from deep underground or water. We've chosen the air that surrounds us all, as the most practical source for a revolutionary form of domestic heating - the Air Source Heat Pump (ASHP).

A typical calculation of power input equalling 1kW will generate 3.4kW output.

Quite simply, thermal energy is extracted from the air and the heat pump boosts it to a higher, more useful temperature for use inside your home. Activair ASHP's are one of the most cost effective ranges of renewable products on the market.

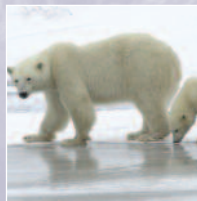

Facts and Statistics

- 84% of energy consumed at home is for heating and hot water.
- UK 2005/06 average winter temperature is 1.1°C min and 6.6°C max.
- UK annual average ambient temperature ranges between 8-11°C.
- The average UK climate is considered ideal for air-water heat pump applications as direct replacements for conventional central heating boilers.
- With space and water heating representing 84% of UK residential energy consumption, replacing conventional central heating boilers with air-water heat pumps is the single largest contribution householders can make towards reducing carbon emissions.

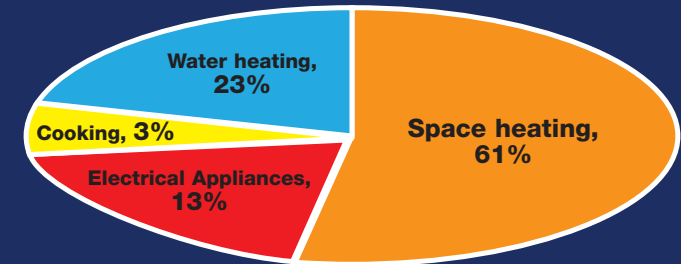

The efficiency of air source heat pumps varies over the year, as ambient air temperatures change. Many air source heat pumps can operate in temperatures as low as -20°C and up to 35°C, but they are at their most efficient in ambient temperatures of 7°C and above. The UK's average ambient temperature is 10°C making air source heat pumps ideal for the UK climate.

SOURCE: MET Office & BRE

With an extremely low purchase price and low installation costs.

The super-clean Heating Machine

The ingenious Activair ASHP

Air Source Heat Pumps are becoming an increasingly popular choice for home heating, especially in areas with less severe winters. But what makes it such a viable heating alternative, and how does it work? Quite simply, the Activair ASHP has a motor powered by electricity that supplies more energy than it consumes when it extracts heat from the surrounding air. For every unit of energy purchased as electricity, several units of heat are delivered, making it up to four times more effective.

Saving energy and preventing pollution

It works in a very similar way to a domestic refrigerator, utilising a working fluid driven around a refrigerant circuit containing four components - an evaporator, a compressor, a condenser and an expansion valve.

The refrigerant liquid circulating within the system has a boiling point as low as -40°C and evaporates when absorbing heat from ambient air. This means it's possible to extract considerable heat from extremely low temperatures. The resulting refrigerant gas is then compressed, adding more heat energy and raising its temperature to around 60°C . This heat is then passed via the heat exchanger into your home for use in your hot water cylinder.

Unique efficiency

This unique product consists solely of one neat, compact unit, complete with refrigerant. The 3 and 5kW are suitable for DHW and can be sited internally or externally. This product can be easily installed in a loft space or externally (with optional adjustable fixing bracket) and quickly plumbed into an indirect cylinder. For those wanting DHW and heating, 12kW and 18kW models are available which are suitable for underfloor or radiator heating, and can only be sited externally. The Activair ASHP is the modern way to harvest yet another natural resource - it satisfies the need to move heat from ambient air, where it's not needed, into the house where it can become an integral part of our domestic comfort in a completely safe and reliable way.



Saving energy... Saving £££'s

Activair ASHPs and underfloor heating are ideally matched. Together they are an extremely efficient and cost effective way of distributing heat by using large floor surfaces rather than radiators. It can also operate at much lower temperatures - ie, as low as 40°C which increases an Activair's COP level, proving these two systems to be ideal companions.

Big savings are achievable when comparing this form of heating with more traditional methods such as a gas boiler operating at an efficiency of around 60%



A 5% saving on energy consumption can be achieved if a condensing boiler is used in conjunction with underfloor heating and a further 15% reduction achievable when used with an Activair air source heat pump.

This modern and efficient form of heating not only provides you with a comfortable home, but also tackles those rocketing fuel bills... making you feel warm all over!

Use less And Get More

Ease of installation

Your Activair ASHP can lead to savings on fossil fuels that would normally be needed to power gas or oil fired boilers in your home. It can also significantly reduce the emission of greenhouse gases - carbon dioxide, sulphur dioxide and nitrogen oxides - into the atmosphere.

Outstanding efficiency

But above all from your point of view, you can expect exceptional fuel savings of up to 60%. In fact, when combined with other energy saving measures, you could save up to £300 per year on your household bills and reduce your carbon dioxide emissions by up to two tonnes*

Competitors' failings

When considering alternative sources of renewable energy, we believe the Activair air to water ASHP is the most logical solution. A ground sourced heat pump is usually much more complicated due to the need for wells or buried coils, together with alterations to land and property. It's therefore much more expensive to install than an air sourced heat pump. Solar power is another option, but is

dependent on good weather for adequate performance levels. Wind turbines obviously depend upon a good supply of wind and as such can fail in sheltered locations whereas Activair will work around the clock, regardless of conditions, in all but the most extreme low temperatures.

A practical alternative

Air heated by the sun however is available to everybody. We have simply tapped into it and are 'harvesting' it in a practical way that doesn't require extensive works, or expensive equipment to install. The Activair ASHP is affordable, compact and unobtrusive. It's finished in a durable weather resistant casing, and carries a comprehensive guarantee on all parts. Minimal maintenance is required and it's completely safe. For optimum performance we recommend a cylinder replacement.

Given the holistic view that governments, local authorities, businesses and individuals are having to take on the worsening threat of global warming, it's nice to know that there's one company that regards it all as more than just hot air. At Trianco we're creating a sustainable future entirely out of thin air.



A renewable energy that's efficient all year round

Frequently asked questions

Are air source heat pumps better than solar panels or ground source heat pumps?

In most cases yes, a ground source heat pump is usually much more complicated due to the need for wells or buried coils, together with alterations to land and property an expensive installation is usually the case. With solar power there is a dependency on fine weather for adequate performance levels. Activair will work around the clock, regardless of conditions, in all but the most extreme low temperatures, and is a cheaper solution both on purchase and installation.

How easy is Activair to install?

Any competent heating engineer should be capable of installing an air source heat pump as no handling of refrigerant is involved. A simple connection to a suitable heating system and electrical connection is required.

What size Activair do I require?

A engineer would have to calculate to suit the installation requirements, as various factors need to be taken into account i.e. size of property, heating requirements.

How much can I expect to pay for an Activair air source heat pump?

You can expect to pay around £2000 for supply and installation of an 'Activair' 3kW for example (subject to survey and assessment from an engineer)

What are the running costs?

This would depend on the tariff of electricity used, Activair can achieve upto 4 times its kW input, capable of providing substantial savings on energy bills.

How much money can I expect to save if I have an Activair installed?

An average household using oil or gas could expect to make substantial savings on fuel bills of up to 60% when having an Activair unit installed.

What are the noise levels?

Noise levels vary from 52 decibels upwards, and can be compared to that of a chest freezer for example.

Is there any government funding available for air source heat pumps?

Grants are provided for renewable energy products, and air source heat pumps are currently being assessed for grant funding by the government.

Making Green more affordable

Performance Data

Coefficient of Performance

The coefficient of performance, or COP, of a heat pump is the ratio of the output heat to the input supplied.

An air source heat pump operating at COP of 3.0, will provide 3.00kW of heat output for every 1kW of unit input (energy consumed).

The average yearly temperature in the UK is 10-11 degrees. Assuming this, the Activair 12kW presents an impressive average COP of around 3.0 - 3.5

The table below is an example of a COP calculation for the Activair 12kW.

Ambient Temp (°C)	Input (kW)	Output (kW)	COP*
5	2.35	5.4	2.3
10	2.85	10.3	3.61
15	3.0	12.0	4.0

*Coefficient of Performance

BRE standard:	
Ambient temp	7°C
Flow rate	35°C
COP	3.2

The COP of heat pumps seem to compare very favourably with high efficiency gas appliance (90-99% efficient), and electric heating (100%), but the full cost of the energy consumed must be considered. Energy from gas is typically much less expensive than that from electricity. However, a heat pump of COP 3.4, such as in the example above, could be less expensive to use than even the most efficient gas appliance.

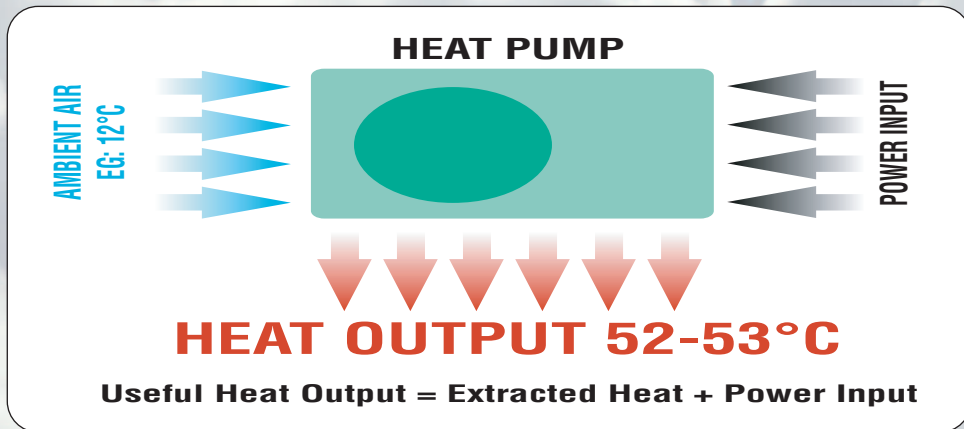

Tests performed by Advantica (a leading independent testing house) showed that at an ambient temperature of 21°C, the Activair 3kW using an input of 1.4kW achieved an output of 4kW, which gave an outstanding overall average efficiency of 305.6%.

- High efficiency
- Compact & unobtrusive
- Nominal 3kW & 5kW output for DHW
- Nominal 12kW output for DHW and underfloor / heating or radiators
- Low energy costs
- Provides high CO2 emissions savings
- Easy to install
- Flexible siting
- Latest compressor technology
- Incorporates circulating pump
- Competitively priced
- Optional stainless steel mounting plates
- Anti frost protection
- 3-year comprehensible warranty.



The Activair comes complete with controls. The user friendly remote controller can be used anywhere in the property. The controller provides many features including 7 day time clock control for heating and hot water. It also monitors the operation, ambient temperatures and displays comprehensive fault diagnosis.

Complete with digital remote programmer

Dimensions & Specifications

CODE	ITEM	HEIGHT	DEPTH	LENGTH	WEIGHT
9003	S300 (3kW)	540mm	260mm	765mm	36Kg
9005	S500 (5kW)	680mm	305mm	800mm	40Kg
9012	S1200 (12kW)	1030mm	748mm	748mm	100Kg
9018S	S1800S (18kW)	1030mm	748mm	748mm	150Kg

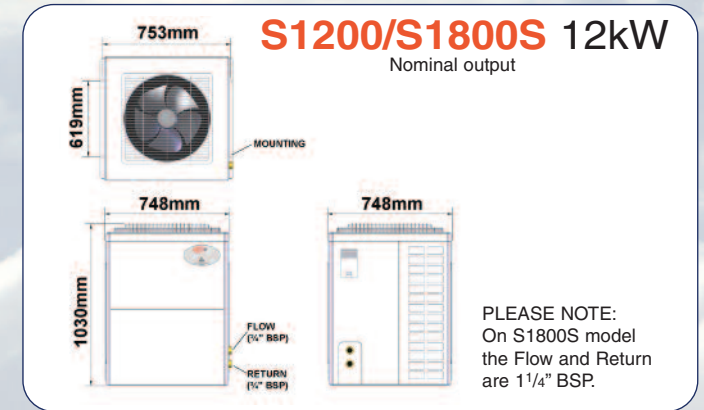
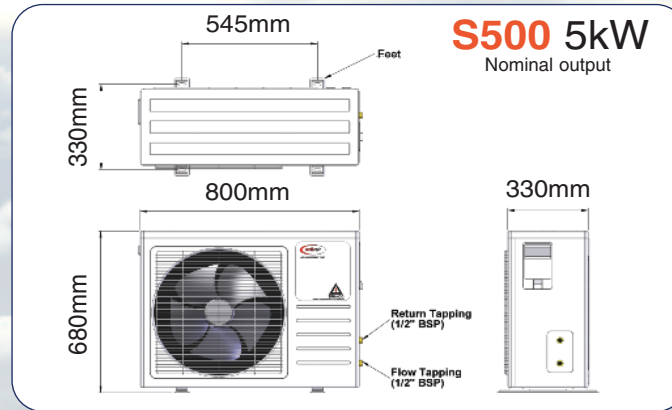
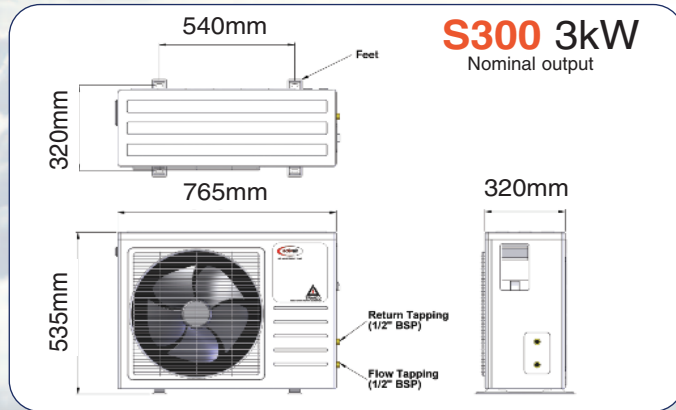

Typical system arrangements

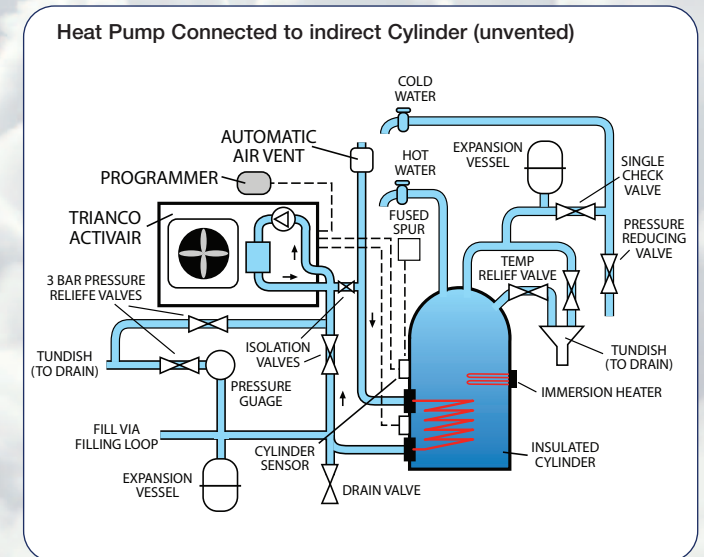
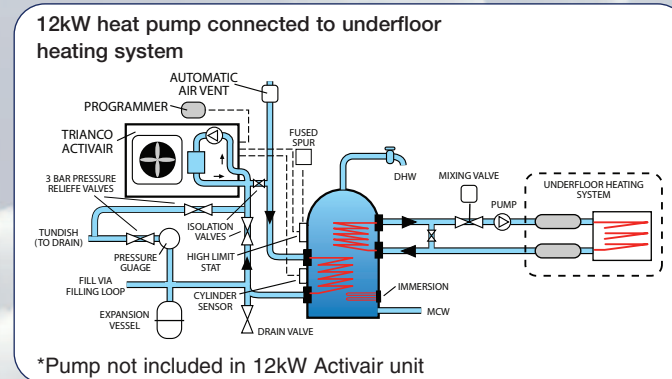
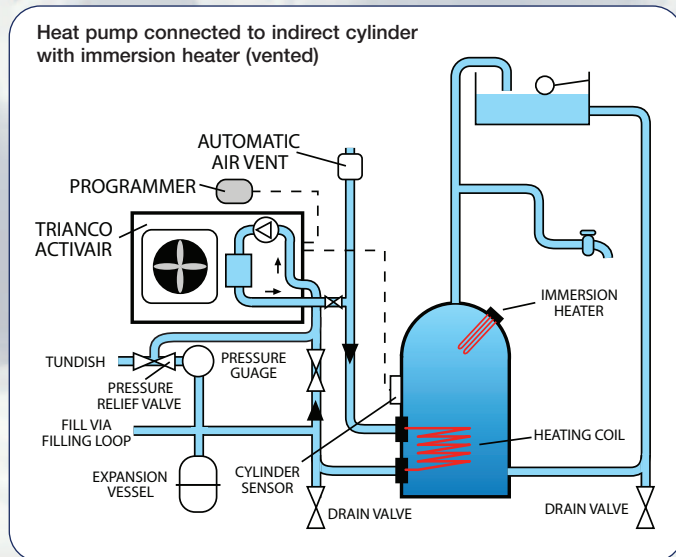

Always refer to the installation instructions before installing an ActivaIR air source heat pump.



Complete heating solutions



Trianco Heating Products Limited, Thornccliffe, Chapeltown,
Sheffield, S35 2PH

Tel: 0114 257 2300 Fax: 0114 257 1419

Visit: www.trianco.co.uk

Copyright of all contents of this brochure is vested in Trianco Heating Products Limited. Any part may not be reproduced without permission. The contents of this brochure are accurate at the date of printing but, because Trianco has a policy of continual development, it may be superseded and should be disregarded if specifications or appearances are changed. The statutory rights of the customer are not affected. Errors and omissions excepted. Issue 2 0609 PN990819.